

Any questions?

Video: Watch assembly instructions online at ledhabitats.com

FAQs visit: www.ledhabitats.com

Contact us

email: customerservice@ledhabitats.com

phone: customer service: 888-201-5533

Other LED Habitats products:

- Seed mats for easy planting: flowers, herbs, and salad greens
- Planting mix for easy seed-starting in your Habitat
- Additional LED Habitats custom planting tray sets

Stay in touch!

LED Habitats is active online. Visit us at ledhabitats.com for more information and links.



LED Habitats LLC
www.ledhabitats.com

LED Habitat and Habitat Pro Assembly Instructions

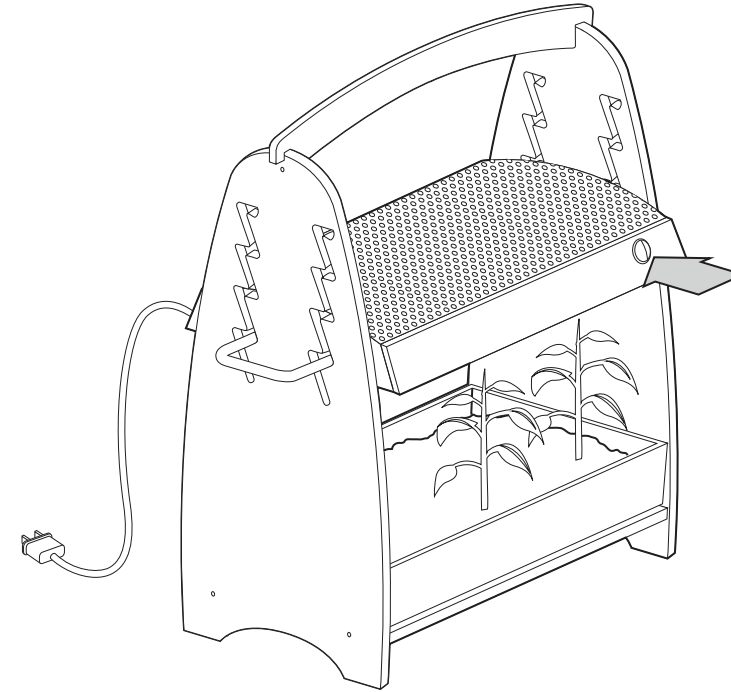

List of Materials LED Habitat:

- Screws (6)
- Bolts (4)
- Handles (2)
- Left Side (1)
- Right Side (1)
- Bottom (1)
- Dome with LED Light (1)
- Top Arch (1)

LED Habitat Pro:

- Add: Screws (2)

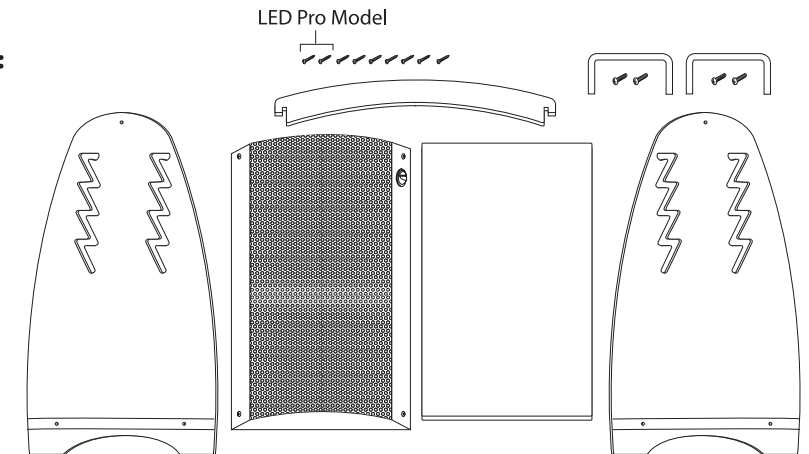

Recommended assembly materials:

- #2 Phillips head screwdriver (included with your Habitat)
- approximately 1" thick book (8.5" x 11" or so in size)
- bath towel or similar sized piece of cloth that can be folded to lie flat

1 Prepare a clean flat surface such as a table for assembly.

2 Lay one side piece flat on the table, groove up.

3 Insert one side of the bottom into the groove on the side piece.

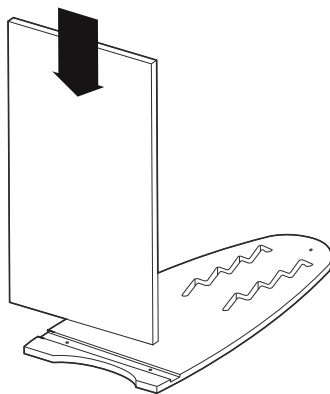

4 Stand the bottom and side piece.

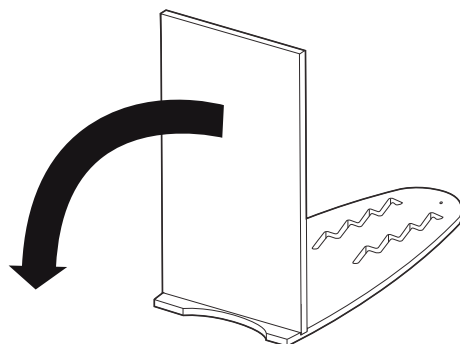

5 Insert the other side of the bottom into the second side piece. Check to make sure the bottom is evenly aligned with the edges of the side pieces before proceeding.

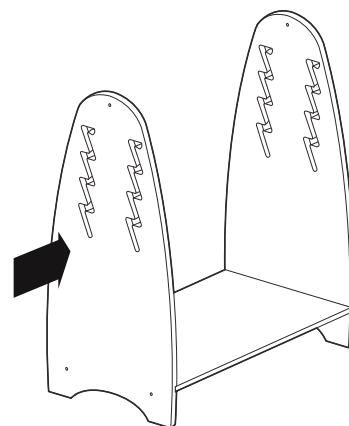

6 Press the top arch piece into the grooves that are on the top of each side piece.

7 Check to make sure both the top and bottom pieces are firmly seated completely into their grooves.

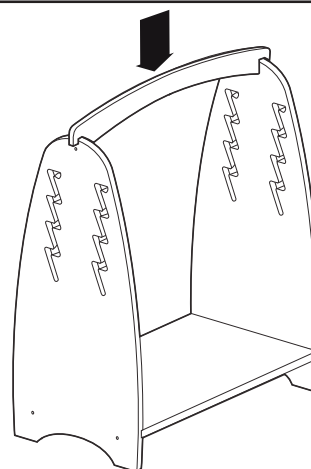

Habitat Pro

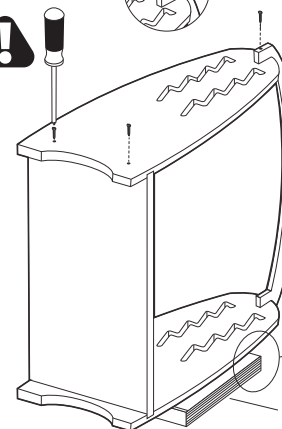

8

Place a book or other approximately 1" thick support on the table, and lay your Habitat on its side on top of the support.

The support will allow the Habitat to lie squarely on its side without rocking on the extended end of the top arch

9

Using a #2 Phillips head screwdriver (provided) and 3 of the six provided screws, attach one side of the bottom piece and top arch, using the pre-drilled holes.



Be certain the screws are inserted squarely—DO NOT continue screwing if you accidentally insert the screw at an angle—withdraw and restart if any screw is not straight as it enters its hole.

Installing the Dome

10

Lay your assembled Habitat stand on to a folded towel or similar cloth that supports the top, slightly raised from the table surface.

11

Check to see that the orientation of the lightning bolts on the side: the bottom line of the zig-zag pattern should be pointing down toward the table surface.

12

Insert the dome into the stand oriented as follows:

- LED lights facing the bottom of the stand
- electrical cord closest to the table
- switch facing upwards
- dome is level, with the pre-drilled holes in the bottom edge aligned with the lightning bolt grooves.

13

Attach one handle at a time to the dome by screwing 2 of the 4 provided bolts from inside the dome into a handle that is held on the outside of the stand. Pass each bolt through one of the pre-drilled holes in the underside of the dome, through the corresponding lightning slot, and into the handle.

